

A-A

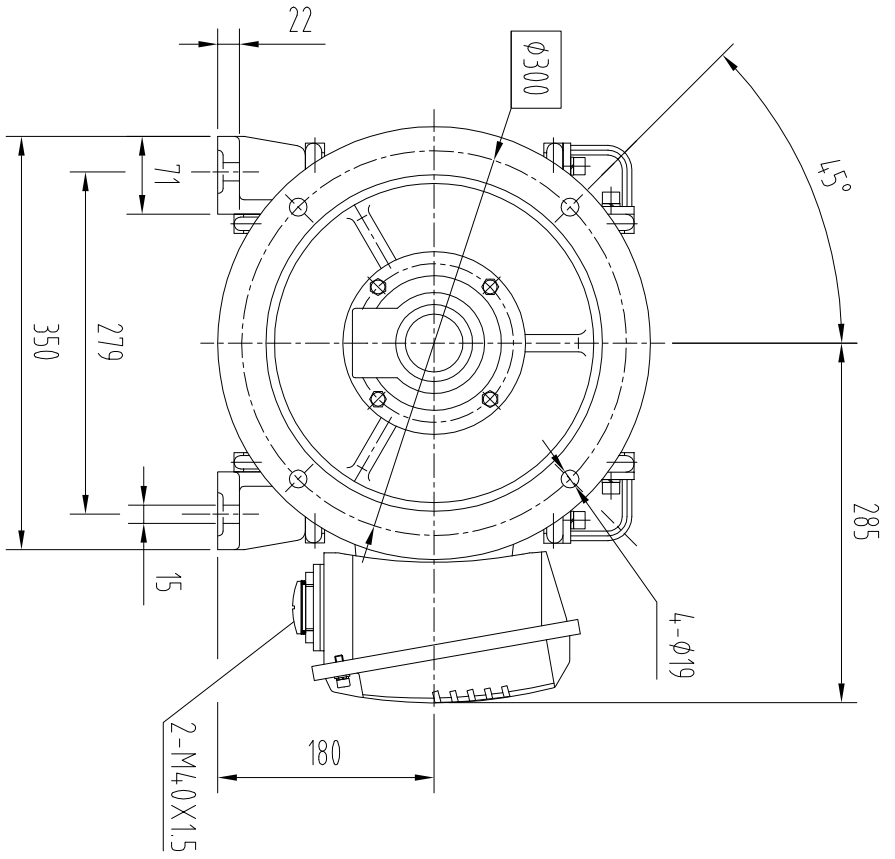

180M-B35-2-8P-M3

MOTOR OUTLINE

EMT OMEC