

A-A

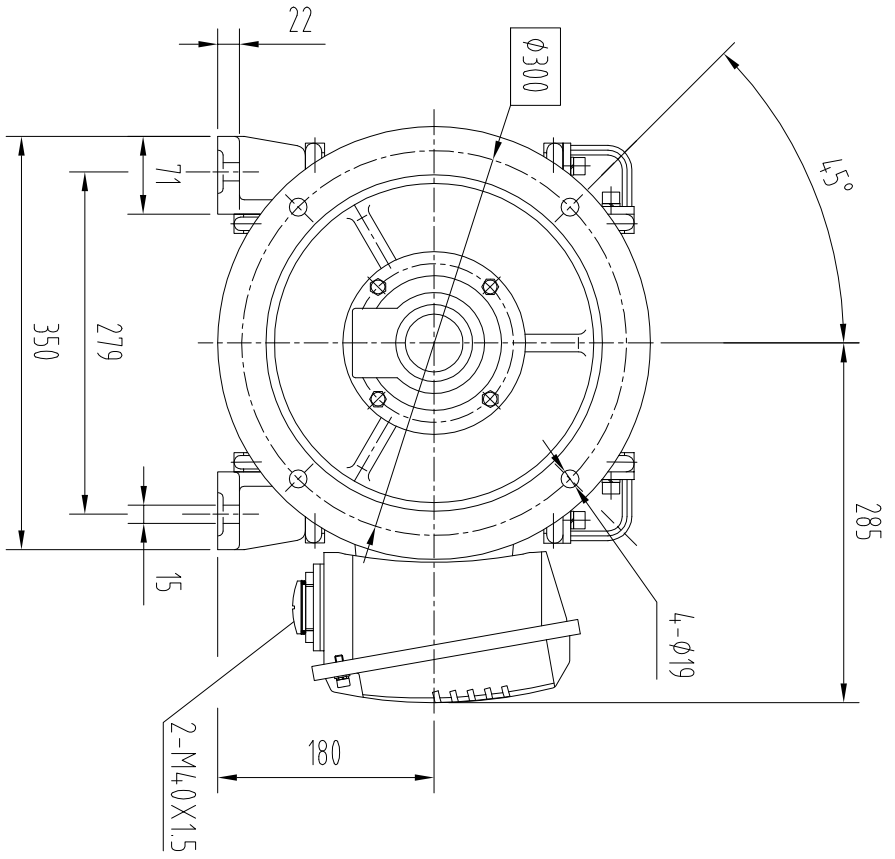

180L-B35-2-8P-M3

MOTOR OUTLINE

EMT OMEC