



# Unidrive M300

Integration through safety and flexible communications

0.25 kW - 110 kW Heavy Duty (0.33 hp - 150 hp)  
100 V | 200 V | 400 V | 575 V | 690 V



Control Techniques™

**EMTOMECH**

# Unidrive M

## Optimized throughput, open automation systems, maximum ease of use

Led by the results of extensive customer-driven market research, we have tailored six Unidrive M feature-sets to specific application needs identified within industrial applications. The Unidrive M300 adds integrated machine safety for open loop applications to the family.

For more information on the full Unidrive M family, please download the Unidrive M: Drives for Industry brochure or the 'Discover Unidrive M' App (available on the App Store, Android and online) via [www.UnidriveM.com](http://www.UnidriveM.com).



# Unidrive M300 features

Optional AI-485 Adaptor for RS485 communications

Optional AI-Back-up Adaptor allows the drive to use an SD card for parameter cloning and acts as an input for 24 V

Optional AI- Smart Adapter has 4GB built-in memory for parameter cloning and 24 V

Optional IP66 (NEMA 4) rated remote keypad with intuitive plain text multilingual back-lit LCD display for rapid set-up and superior diagnostics. An optional IP54 (NEMA 12) remote real time clock keypad is also available.

LED keypad fitted as standard for quick commissioning and ease of use

User-friendly control connections

Useful parameter guide on drive's front panel

Drive rated to IP21 / UL open class (NEMA 1) on size 1 to 4 as standard

Conduit kits are available to meet UL Type 1 rating

System Integration (SI) option module

Dual onboard Safe Torque Off (STO) terminals for easy SIL3 conformity

Conventional surface and DIN rail mounting (Up to 1.5 kW/ 2 hp)\*

Easy-to-disconnect internal EMC filter

User-friendly power connections

Robust cable management system provides grounding point for shielded control and power cables

System Integration (SI) module slot for communications, fieldbus and additional I/O options (frame size 2 and upwards)



\* Additional fixings recommended where heavy vibration is expected

# Unidrive M300

## Integration through safety and flexible communications

Unidrive M300 is ideal for applications that require cost effective integration into safety systems and advanced Rotor Flux Control (RFC-A) open-loop motor control. Unidrive M300 provides an upgrade path for Commander SK users who want a similar feature set with the addition of integrated dual Safe Torque Off (STO) inputs to provide SIL3/PLe conformity and enhanced RFC-A open loop motor control.

### **Integrate Unidrive M300 into any safety system**

With dual STO, M300 can easily become part of machine safety systems and conform to SIL3/PLe. The 'SI' Interface enables further integration with a wide range of available industry standard fieldbuses or extended I/O to allow remote control and diagnostics across different networks. These include SI-Ethernet, SI-EtherCAT, SI-PROFINET, SI-PROFIBUS, SI-CANopen and SI-DeviceNet. Additionally, the AI-485 Adaptor option permits connection to RS485 networks using Modbus RTU.

### **Maximize productivity with performance open-loop motor control**

M300's advanced Rotor Flux Control (RFC-A) utilizes closed-loop current control to give maximum stability of induction motors at all powers. It provides a high bandwidth control algorithm with 125  $\mu$ s current loop update rates and 180 % motor overload for heavy industrial machinery applications.

### **Install and configure quickly and easily**

Unidrive M300 has an easy-to-use fixed LED keypad as standard and a useful parameter guide on the front of the drive to enhance understanding when setting up and interrogating. Parameter sets can be easily saved or transferred between drives using the Unidrive M Connect PC tool or an SD card with AI-Back-up adaptor. An easy fit remote LCD keypad is available for IP66 (NEMA 4) panel mounting and extra diagnostic information. Additionally, a remote real time clock keypad, Remote Keypad RTC, is also available (meets IP54/NEMA 12). Fast install DIN rail mounting is supported up to 1.5 kW (2 hp)\*.

\*Additional fixings recommended where heavy vibration is expected

---

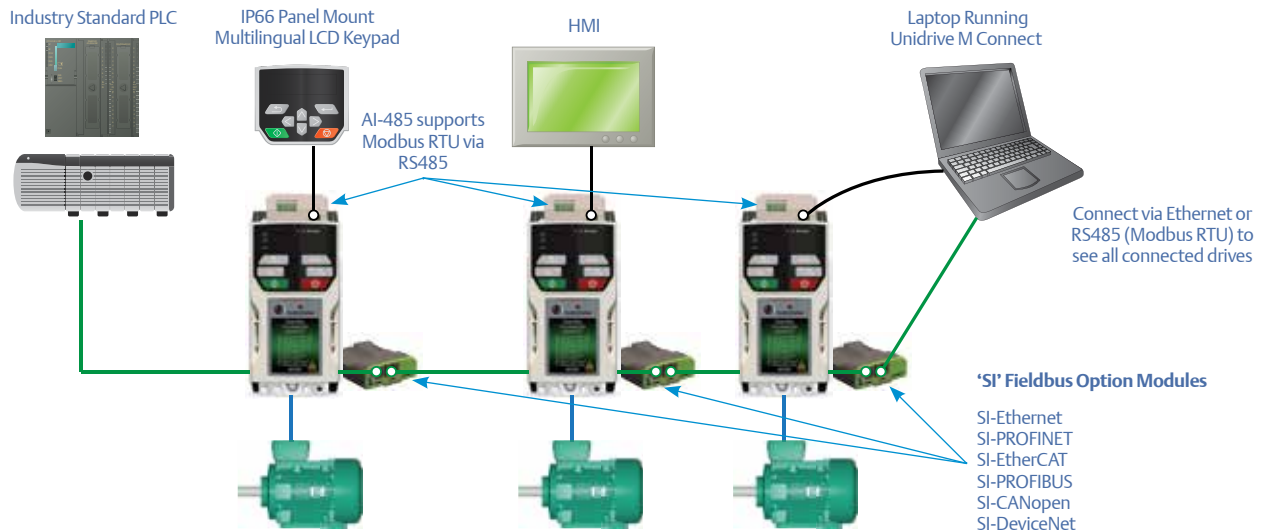

## Transfer parameters without mains power

For fast, serial machine production, the AI-Back-up Adaptor option can be powered by 24 V to transfer parameter sets to and from standard SD Cards.

## Minimize downtime with robust and reliable design

Unidrive M300 is extremely reliable due to a design based on over 40 years of drive knowledge, expertise and development. Build quality is ensured using world leading manufacturing processes. M300 is packed with features proven to keep systems running in environments as described by IEC60721-3-3 3C3 and EN60068-2-60 Meth. 4.

- PCBs have conformal coating to further increase resilience to harsh environmental conditions
- A patented air flow system cools the drive more effectively and protects internal components
- Wide supply voltage tolerance keeps drive operation smooth in areas where supplies are variable
- Intelligent 3 speed user-replaceable cooling fan with patented fan-fail detection circuit
- Trip avoidance features take intelligent action instead of tripping out critical processes. For example:
  - ⇒ Load Shedding reduces speed at current limits
  - ⇒ Supply loss ride-through keeps running during brown outs

- Derating values are available so that M300 can be run in higher temperature environments
- High overload capability - 180 % for 3 s or 150 % for 60 s
- Ingress protection up to IP21- UL open class (NEMA 1) compliance

## Reduce application size and cost

Unidrive M300's compact drive dimensions are among the smallest in class at every power rating.

## Upgrade Commander SK designs and installations with Safe Torque Off

Unidrive M300 is designed for easy migration from Commander SK. Tools are available for fast and easy installation:

- Compatible dimensions, along with retrofit kits, mean that M300 can easily fit into Commander SK locations using existing fittings
- Same power and control wiring philosophy
- Parameter porting from Commander SK to Unidrive M300 is supported by the Unidrive M Connect software tool

## Typical applications

Speed control for material transport and cutting, woodworking and machine tools where protection to people or assets is required to SIL3/PLC

# Motor control performance and energy saving

## Performance motor control

Unidrive M300 combines the latest microprocessor technology with unique motor control algorithms to give maximum stability of induction motors at all powers. Current loop update rates up to 125  $\mu$ s and complementary intelligent control features ensure that machine throughput and energy efficiency are maximized in all industrial applications.

The range of motor control modes available includes:

Control Mode	Features
Enhanced open loop Rotor Flux Control for induction motors (RFC-A)	High performance speed and torque control through an advanced vector algorithm, utilizing closed loop current control to greatly enhance performance for all induction motor sizes without the need for a feedback device.
Open loop vector or V/Hz induction motor control	Reliable performance and easy configuration <ul style="list-style-type: none"><li>• 100% torque available down to 1 Hz</li><li>• Slip compensation</li><li>• Multi-motor control</li><li>• Square law V/F mode</li><li>• Dynamic V/F mode</li></ul>

## Easy motor pairing

Several intuitive tools are available to guarantee fast and optimized pairing between Unidrive M300 and AC induction motors. These include:

- Easy-to-use keypad with parameter reference guide on front panel
- Multilingual LCD remote keypad with clear parameter and diagnostic descriptions (remote real time clock keypad also available)
- Two autotune procedures (stationary and rotating) to automatically optimize motor and drive configuration
- Unidrive M Connect software tool provides a comprehensive motor database and set up wizard

## Energy saving

With energy costs a key factor in many industries, Unidrive M is packed with features to enhance energy efficiency:

- Low power standby mode for applications where drives can sit idle for significant periods
  - Automatic 3-speed cooling fan keeps energy usage and acoustic noise to a minimum by intelligently responding to load and environmental conditions
  - Square law V/F mode is optimized for quadratic loads like pumps and fans to keep motor losses to a minimum
  - Dynamic V to F mode keeps energy usage and motor losses to a minimum in low load conditions
  - Unidrive M300 is highly efficient (above 98%)
-





# Unidrive M300 option choices and terminal layout

## Control Mode

1. Open loop vector or V/Hz induction motor control
2. Open loop Rotor Flux Control for induction motors (RFC-A)



## Input/Output

SI-I/O



- 4 x Digital I/O
- 3 x Analog inputs (default) / Digital inputs
- 1 x Digital input
- 2 x Relays

Onboard



- 3 x Analog I/O
- 5 x Digital I/O
- 2 x STO
- 1 x Relay

## Communications

AI-485 Adaptor



SI-EtherCAT



SI-PROFIBUS



SI-Ethernet



SI-DeviceNet



SI-CANopen



SI-PROFINET



## DC back-up power supply



AI-Back-up Adaptor and AI-Smart adaptor (Input for 24 V back-up)







## Optional Drive Programming and Operator Interface

Unidrive M Connect



Remote Keypad (LCD)



M300 - Fixed LED keypad



Remote keypad RTC



Operator Interface



AI-Back-up Adaptor  
(provides SD card usage for programming / cloning)



AI-Smart Adaptor  
(provides SD card (supplied) usage for programming / cloning)



## Terminal Layout

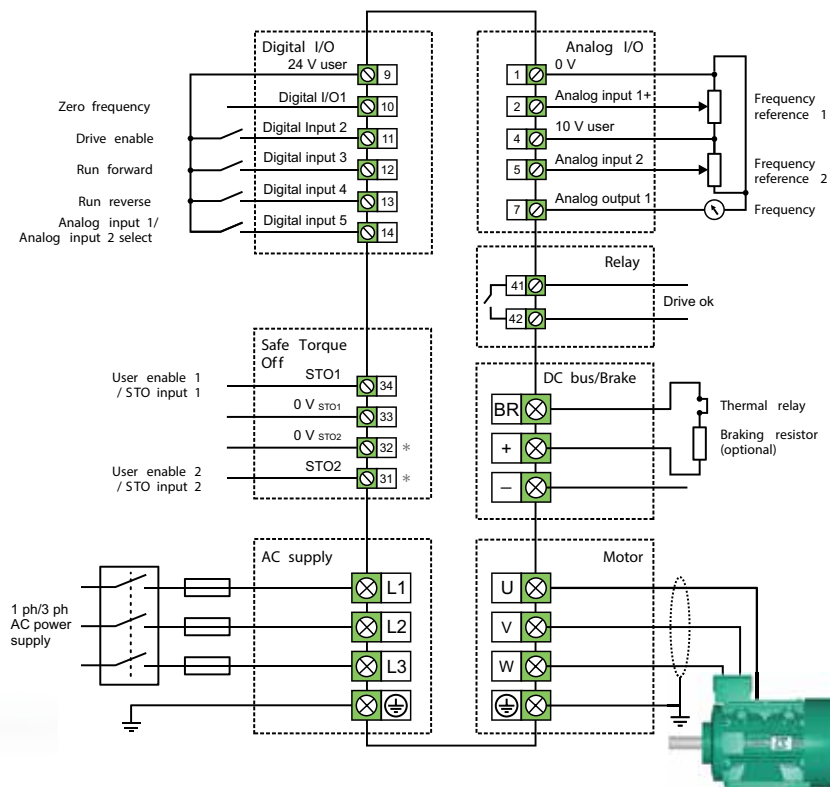



\* For frame sizes 5 - 9 STO input 2 becomes terminal 35 and 0V becomes terminal 36

# Fast and easy set-up, monitoring and diagnostics

Unidrive M keypads, memory devices and software tools make it easy to access Unidrive M300's full feature set, allowing users to optimize drive tuning, back-up parameters and troubleshoot more quickly.

## User interface options

Unidrive M benefits from a number of optional keypad choices to meet your application needs.

Type		Benefit
Fixed LED keypad		Simple LED keypad fitted as standard for quick and easy commissioning and use.
Remote Keypad		Remote mountable, intuitive plain text, multilingual LCD keypad for rapid set-up and superior diagnostics (using the AI-485 Adaptor along with a comms lead). Rapid and secure panel fit with 1 x 32 mm hole rated to IP66 (NEMA 4).
Remote keypad RTC		The keypad is remote mountable, allowing flexible mounting on the outside of a panel (meets IP54/ NEMA 12). Three line plain text, multi-language LCD keypad for rapid set-up and helpful diagnostics. Battery operated real-time clock allows accurate time stamping of events, aiding diagnostics.



## Unidrive M Connect commissioning tool

Unidrive M Connect is our latest drive configuration tool for commissioning, optimizing and monitoring drive/system performance. Its development draws from extensive user research, using human centered design principles to give the ultimate user experience:

- Task based commissioning is simplified via familiar Windows interface
- Intuitive graphical tools enhance and simplify user experience
- Dynamic drive logic diagrams and searchable listings
- Drive and motor performance can be optimized with minimal specialized drive knowledge
- Supports the import of Commander SK parameter files and allows full drive cloning
- Multiple simultaneous communications channels for a more complete overview of the system
- Drive discovery gives the ability to find drives on a network automatically without the user having to specify their addresses
- Automatic RTU baud rate scanning on the Unidrive M300 RS485 connection

## Portable SD memory card

Unidrive M300 uses popular SD cards for quick and easy parameter and program storage using the AI-Back-up Adaptor.

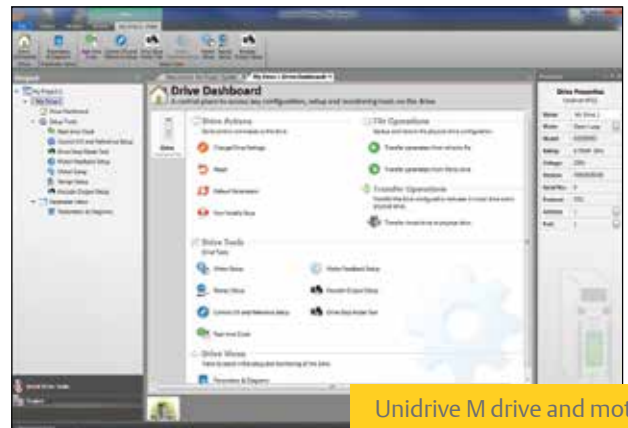

Unidrive M drive and motor set-up tool screen

# Unidrive M300 ratings and specifications

## Key:

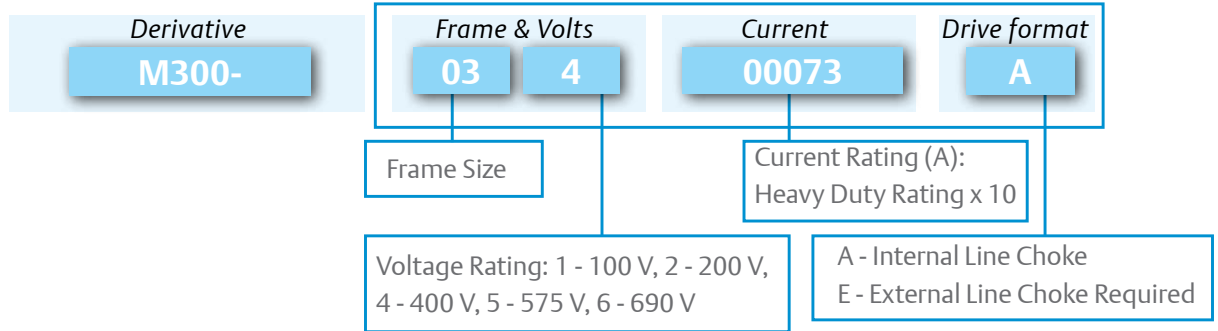

100/120 Vac ±10 %						
Order Code	Supply Phases	Heavy Duty			Normal Duty	
		Max Continuous Current (A)	Motor Shaft Power (kW)	Motor Shaft Power (hp)	Max Continuous Current (A)	Motor Shaft Power (kW)
M300-011 00017A	1	1.7	0.25	0.33	For Normal Duty applications, use Heavy Duty ratings.	
M300-011 00024A	1	2.4	0.37	0.5		
M300-021 00042A	1	4.2	0.75	1		
M300-021 00056A	1	5.6	1.1	1.5		

200/240 Vac ±10 %							
Order Code	Supply Phases	Heavy Duty			Normal Duty		
		Max Continuous Current (A)	Motor Shaft Power (kW)	Motor Shaft Power (hp)	Max Continuous Current (A)	Motor Shaft Power (kW)	Motor Shaft Power (hp)
M300-012 00017A	1	1.7	0.25	0.33	For Normal Duty applications, use Heavy Duty ratings.		
M300-012 00024A	1	2.4	0.37	0.5			
M300-012 00033A	1	3.3	0.55	0.75			
M300-012 00042A	1	4.2	0.75	1			
M300-022 00024A	1/3	2.4	0.37	0.5			
M300-022 00033A	1/3	3.3	0.55	0.75			
M300-022 00042A	1/3	4.2	0.75	1			
M300-022 00056A	1/3	5.6	1.1	1.5			
M300-022 00075A	1/3	7.5	1.5	2			
M300-032 00100A	1/3	10	2.2	3			
M300-042 00133A	1/3	13.3	3	3			
M300-042 00176A	3	17.6	4	5			
M300-052 00250A	3	25	5.5	7.5			30
M300-062 00330A	3	33	7.5	10	50	11	15
M300-062 00440A	3	44	11	15	58	15	20
M300-072 00610A	3	61	15	20	75	18.5	25
M300-072 00750A	3	75	18.5	25	94	22	30
M300-072 00830A	3	83	22	30	117	30	40
M300-082 01160A	3	116	30	40	149	37	50
M300-082 01320A	3	132	37	50	180	45	60
M300-092 01760A	3	176	45	60	216	55	75
M300-092 02190A	3	219	55	75	266	75	100
M300-092 01760E	3	176	45	60	216	55	75
M300-092 01760E	3	219	55	75	266	75	100

380/480 Vac ±10 %							
Order Code	Supply Phases	Heavy Duty			Normal Duty		
		Max Continuous Current (A)	Motor Shaft Power (kW)	Motor Shaft Power (hp)	Max Continuous Current (A)	Motor Shaft Power (kW)	Motor Shaft Power (hp)
M300-024 00013A	3	1.3	0.37	0.5	For Normal Duty applications, use Heavy Duty ratings.		
M300-024 00018A	3	1.8	0.55	0.75			
M300-024 00023A	3	2.3	0.75	1			
M300-024 00032A	3	3.2	1.1	1.5			
M300-024 00041A	3	4.1	1.5	2			
M300-034 00056A	3	5.6	2.2	3			
M300-034 00073A	3	7.3	3	3			
M300-034 00094A	3	9.4	4	5			
M300-044 00135A	3	13.5	5.5	7.5			
M300-044 00170A	3	17	7.5	10			
M300-054 00270A	3	27	11	20	30	15	20
M300-054 00300A	3	30	15	20	31	15	20
M300-06400350A	3	35	15	25	38	18.5	25
M300-064 00420A	3	42	18.5	30	48	22	30
M300-064 00470A	3	47	22	30	63	30	50
M300-074 00660A	3	66	30	50	79	37	60
M300-074 00770A	3	77	37	60	94	45	75
M300-074 01000A	3	100	45	75	112	55	75
M300-084 01340A	3	134	55	100	155	75	100
M300-084 01570A	3	157	75	125	184	90	125
M300-094 02000A	3	200	90	150	221	110	150
M300-094 02240A	3	224	110	150	266	132	200
M300-094 02000E	3	200	90	150	221	110	150
M300-094 02240E	3	224	110	150	266	132	200

500/575 Vac ±10 %							
M300-055 00030A	3	3	1.5	2	3.9	2.2	3
M300-055 00040A	3	4	2.2	3	6.1	4	5
M300-055 00069A	3	6.9	4	5	10	5.5	7.5
M300-065 00100A	3	10	5.5	7.5	12	7.5	10
M300-065 00150A	3	15	7.5	10	17	11	15
M300-065 00190A	3	19	11	15	22	15	20
M300-065 00230A	3	23	15	20	27	18.5	25
M300-065 00290A	3	29	18.5	25	34	22	30
M300-065 00350A	3	35	22	30	43	30	40
M300-075 00440A	3	44	30	40	53	37	50
M300-075 00550A	3	55	37	50	73	45	60
M300-085 00630A	3	63	45	60	86	55	75
M300-085 00860A	3	86	55	75	108	75	100
M300-095 01040A	3	104	75	100	125	90	125
M300-095 01310A	3	131	90	125	150	110	150
M300-095 01040E	3	104	75	100	125	110	125
M300-095 01310E	3	131	90	125	150	110	150

500/690 Vac ±10 %							
M300-076 00190A	3	19	15	20	23	18.5	25
M300-076 00240A	3	24	18.5	25	30	22	30
M300-076 00290A	3	29	22	30	36	30	40
M300-076 00380A	3	38	30	40	46	37	50
M300-076 00440A	3	44	37	50	52	45	60
M300-076 00540A	3	54	45	60	73	55	75
M300-086 00630A	3	63	55	75	86	75	100
M300-086 00860A	3	86	75	100	108	90	125
M300-096 01040A	3	104	90	125	125	110	150
M300-096 01310A	3	131	110	150	155	132	175
M300-096 01040E	3	104	90	125	125	110	150
M300-096 01310E	3	131	110	150	155	132	175



# Unidrive M300 ratings and specifications

## Environmental safety and electrical conformance

- **Size 1 to 4:**  
IP21 / UL open class (NEMA 1). IP20 when the AI-Back-up or AI-485 Adaptors are fitted.  
UL TYPE 1 compliance requires the appropriate conduit kit to be fitted.
- Ambient temperature -20 °C (4 °F) to 40 °C (104 °F) as standard. 60 °C/ 140 °F with derating for frames 1-4.
- **Size 5 to 9:**  
IP20 / UL open class (NEMA 1). UL TYPE 1 compliance requires the appropriate conduit kit to be fitted.  
IP65 / UL TYPE 12 rating is achieved on the rear of the drive when through panel mounted (9E is IP55).
- Ambient temperature -20 °C (4 °F) to 40 °C (104 °F) as standard. 55 °C/ 131 °F with derating for frames 5-9.
- Storage temperature -40 °C to 60 °C (-40 °F to 140 °F).
- Humidity 95 % maximum (non-condensing) at 40 °C (104 °F) in accordance with EN/IEC 60068-2-78 and ANSI/EIA-364-31.
- EN/IEC 60068-2-60, Method 4 Corrosive gas.
- Altitude: 0 to 3000 m (0 to 9843 ft), derate 1 % per 100 m (328 ft) between 1000 m and 3000 m (3281 ft and 9843 ft).
- Random Vibration: Tested in accordance with EN/IEC 60068-2-64 with SI and AI option modules fitted.
- Mechanical Shock: Tested in accordance with EN/IEC 60068-2-29.
- Electromagnetic Immunity complies with EN/IEC 61800-3 and EN/IEC 61000-6-2.
- With onboard EMC filter, complies with EN/IEC 61800-3 (2nd environment).
- EN/IEC 61000-6-3 and EN/IEC 61000-6-4 with optional footprint EMC filter.
- EN/IEC 60146-1-1 Supply conditions.
- EN/IEC 61800-5-1 Electrical Safety.
- EN/IEC 61131-2 I/O.
- Safe Torque Off, independently assessed by TÜV to EN/IEC 61800-5-2 SIL3 and EN ISO 13849-1 PL<sub>e</sub>.
- UL 508C Electrical Safety.

## Unidrive M300 features and specification table

Performance	Current loop update: 125 µs
	Heavy Duty peak rating: 180 % (3 s), 150 % (60 s)
	Normal Duty peak rating: 110 % (165 s)
	Maximum output frequency: 550 Hz
Mechanical attributes	Switching frequency range: 0.67, 1, 2, 3, 4, 6, 8, 12, 16 kHz (3 kHz default)
	DIN rail mountable (size 1 and 2) up to 1.5 kW (2 hp)*
Parameter back-up	Commander SK compatible mechanical footprint either as standard or with conversion plates
	Unidrive M Connect
Onboard I/O	SD card (using optional AI-Back-up Adaptor)
	Smart Adaptor
Back-up power	2 x Analog inputs, 1 x Analog output
	4 x Digital inputs, 1 x Bidirectional digital input or output
	1 x Relay output
Other	24 V control back-up (using optional AI-Back-up Adaptor) AI-Smart Adaptor (Built-in memory for parameter cloning and 24 V back-up)
	Temperature controlled fan with standby (off)
	User replaceable fan(s)
	Conformal coating IEC 60721-3-3 3C3
	Standby mode (energy saving)
	User defined security levels (e.g. restricted access or read-only parameters via user defined security code)

\*Additional fixings recommended where heavy vibration is expected

## Dimensions and Weight



Frame Size		1	2	3	4	5	6	7	8	9A	9E
Dimensions (H x W x D)	mm	137x75x130	180x75x150	200x90x160	245x115x175	365x143x192	365x210x221	508x270x280	753x310x290	1049x310x290	1010x310x290
	in	5.4x3.0x5.1	7.1x3.0x5.9	7.9x3.5x6.3	9.7x4.5x6.9	14.4x5.6x7.6	14.4x8.3x8.7	20x10.6x11	29.6x12.2x11.4	41.3x12.2x11.4	39.8x12.2x11.4
Weight	kg (lb)	0.75(1.65)	1.0(2.2)	1.5(3.3)	3.13(6.9)	7.4(16.3)	14(30.9)	45(99.2)	50(110.2)	66.5(146.6)	46(101.4)

### Notes:

Height dimension (H) does not include fixed mounting feet on sizes 1 to 4 or removable mounting brackets on sizes 5-9E  
Additional distance should be added to the height dimension (H) when the following options are fitted:

- AI-Back-up Adaptor: 15 mm (0.59 in)
- AI-485 Adaptor: 26 mm (1.02 in)
- AI-Smart Adaptor: 15 mm (0.59 in)

## Optional keypad

Description/Order code	Order code
Remote Keypad	82500000000001
Remote keypad RTC	82400000019600

## Optional accessories

Description/Order code	Order code
AI-Back-up Adaptor	825000000000004
AI-485 Adaptor	825000000000003
AI-Smart Adaptor	82500000018500

## Through hole IP65 kit

IP65 / UL TYPE 12 rating is achieved on the rear of the drive when through panel mounted using the following kits.

Frame size	Order code
5	3470-0067
6	3470-0055
7	3470-0079
8	3470-0083
9A	3470-0119
9E	3470-0105

## UL Type 1 Conduit kit

Frame size	Order code
1	3470-0091
2	3470-0094
3	3470-0098
4	3470-0102
5	3470-0069
6	3470-0059
7	3470-0080
8 / 9A	3470-0088
9E	3470-0115

## Retrofit mounting brackets

These mounting brackets ensure the drive can be mounted on existing Commander SK installations.

Frame size	Order code
3	3470-0097
4	3470-0101
5	3470-0066
6	3470-0074
7	3470-0078
8	3470-0087
9A / 9E	3470-0118

## Line reactor

Frame size	Order code
9E (400 V)	7022-0063
9E (600 V)	7022-0063

## Finger-guard grommet

Frame size	Order code
9A / 9E	3470-0107

## Lifting tool

Frame size	Order code
9A	7778-0045
9E	7778-0016

## Fan replacement kit

Frame size	Order code
1	3470-0092
2	3470-0095
3	3470-0099
4	3470-0103

## Optional external EMC filters

Unidrive M built-in EMC filter complies with EN/IEC 61800-3. External EMC filters are required for compliance with EN/IEC 61000-6-4 as per the table below.

Frame size	Voltage	Phases	Type	Order code	
1	All	1	Standard	4200-1000	
		1	Low leakage	4200-1001	
2	100 V	1	Standard	4200-2000	
		1	Standard	4200-2001	
		1	Low leakage	4200-2002	
	200 V	3	Standard	4200-2003	
		3	Low leakage	4200-2004	
		3	Standard	4200-2005	
3	400 V	3	Low leakage	4200-2006	
		1	Standard	4200-3000	
		1	Low leakage	4200-3001	
	200 V	3	Standard	4200-3004	
		3	Low leakage	4200-3005	
		3	Standard	4200-3008	
4	400 V	3	Low leakage	4200-3009	
		1	Standard	4200-4000	
		1	Low leakage	4200-4001	
	200 V	3	Standard	4200-4002	
		3	Low leakage	4200-4003	
		3	Standard	4200-4004	
5	400 V	3	Low leakage	4200-4005	
		200 V	3	Standard	4200-0312
		400 V	3	Standard	4200-0402
6	575 V	3	Standard	4200-0122	
		200 V	3	Standard	4200-2300
		400 V	3	Standard	4200-4800
7	575 V	3	Standard	4200-3690	
		200 V & 400V	3	Standard	4200-1132
		575 V & 690V	3	Standard	4200-0672
8	575 V & 690V	200 V & 400V	3	Standard	4200-1972
		575 V & 690V	3	Standard	4200-1662
9	575 V & 690V	200 V & 400V	3	Standard	4200-3021
		575 V & 690V	3	Standard	4200-1660

For a full list of patents and patent applications, visit [www.controltechniques.com/patents](http://www.controltechniques.com/patents).