

Shaft detail

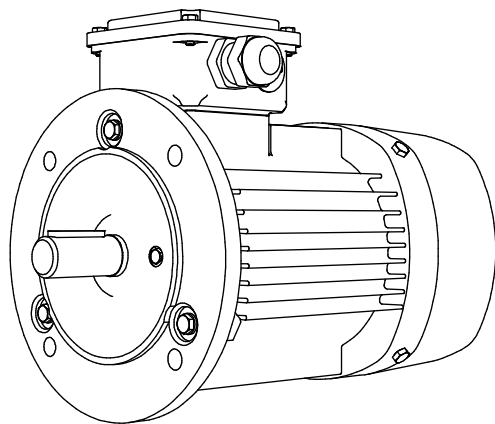
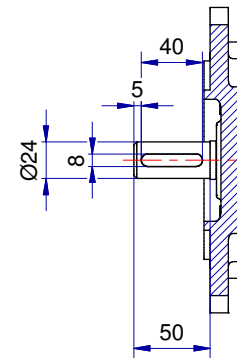

01-IP55-Cast Iron-IE2-90S B5-2_8