

Shaft detail

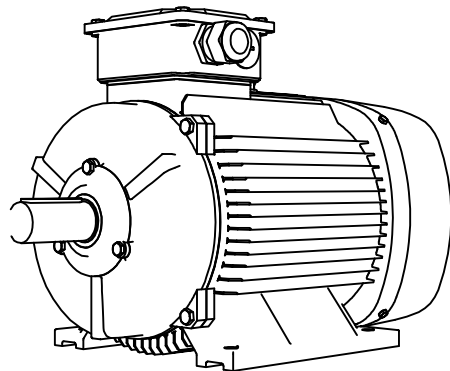
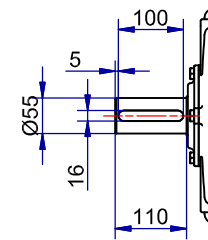

01-IP55-Cast Iron-IE2-200L B3-2