

Shaft detail

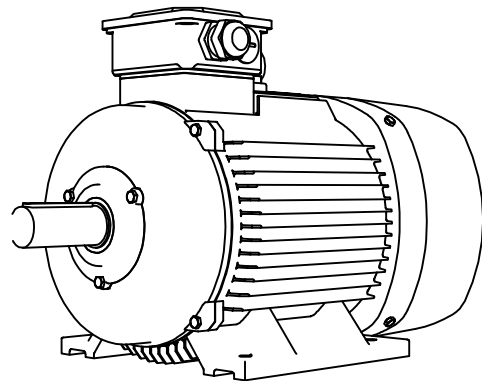

01-IP55-Cast Iron-IE2-180M B3-2_8